

ISLE ARMCHAIR

ASSEMBLY INSTRUCTIONS

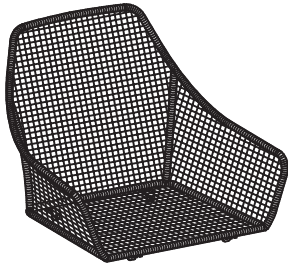

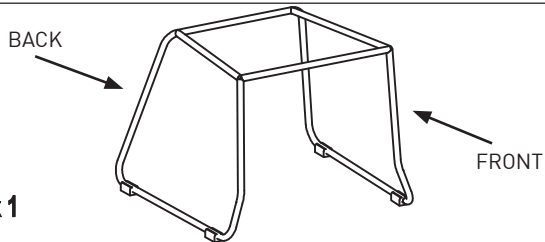



A x 1



B x 1

LIST OF HARDWARE

NO.	HARDWARE	QTY.
1	Bolt 	04
2	Split lock washers $\varnothing 10/\varnothing 6$ 	04
3	Washer $\varnothing 12/\varnothing 6$ 	04
4	Allen key 	01

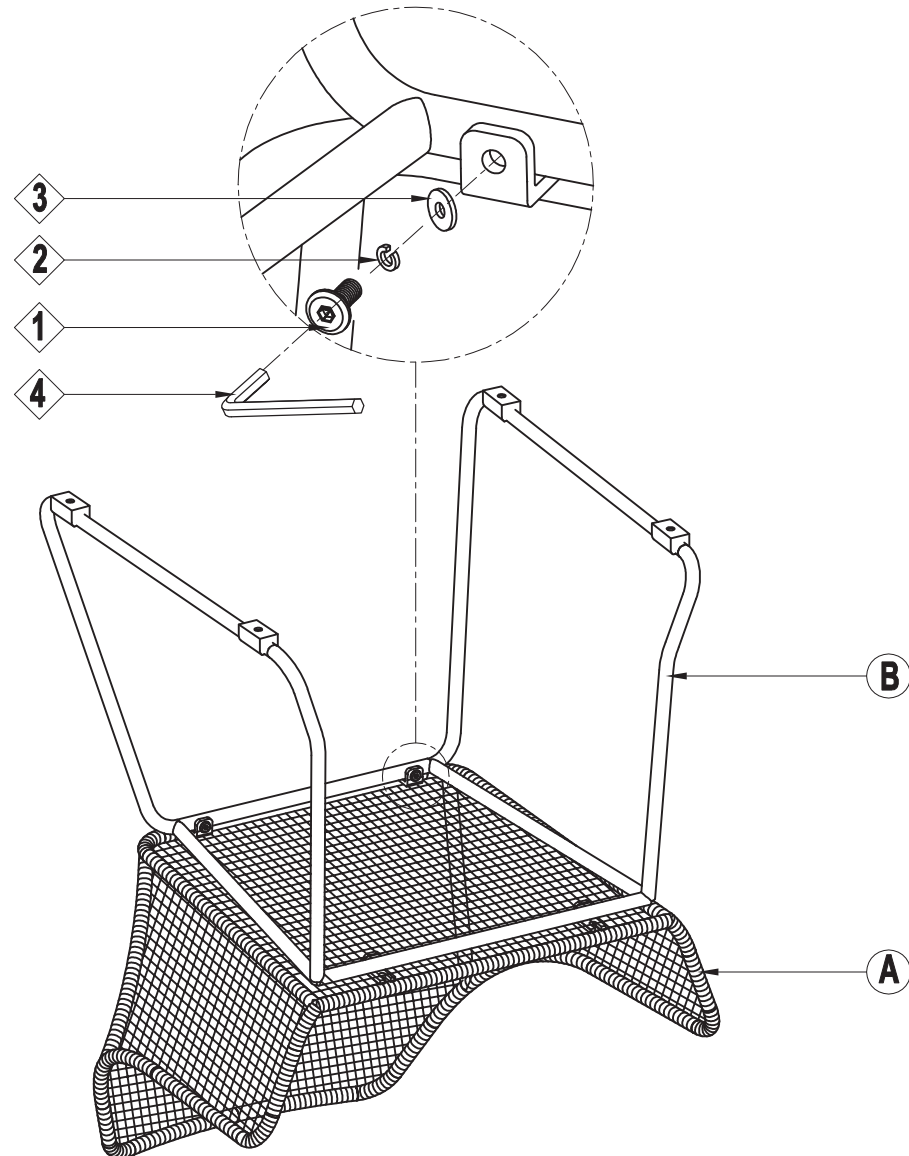

ISLE BARSTOOL

ASSEMBLY INSTRUCTIONS





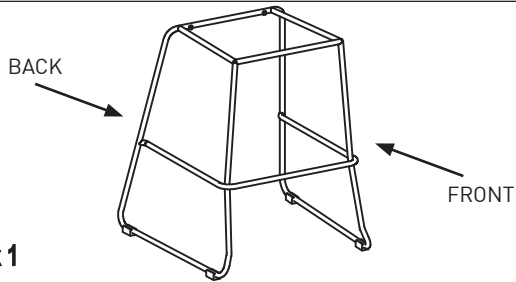

A x 1



B x 1

LIST OF HARDWARE

NO.	HARDWARE	QTY.
1	Bolt 	04
2	Split lock washers Ø10/Ø6 	04
3	Washer Ø12/Ø6 	04
4	Allen key 	01

